

4.9 ★★★★★  
rating on Google reviews

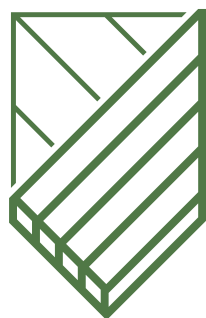

# DECK ZONE

## 2025 CATALOG

717-269-7584

Specializing in  
Custom Decks • Porches • Four season rooms





# CONTENTS

<b>About Us</b> .....	2	American Series.....	16	<b>Roof Overs Gallery</b> .....	37
Our Service Area.....	2	Rod Rail Infill.....	17	Porch Roof Material Options ..	38
Our Process .....	3	Cable Rail Infill.....	17-18	Roof Shingle Color Chart.....	38
Payment Plan Options.....	3	Chesapeake Series .....	19	<b>Porch Ceilings</b> .....	38-43
Deck Model Average Prices.....	4	Drink Rail .....	19	Ceiling Beams.....	39
Our Warranty .....	4	Infill Options Gallery .....	20-21	Ship Lap Wall & Ceiling Board	39
<b>Decking Comparison Chart</b> .....	5	Outlook Series.....	22-23	Wood Soffit Options.....	40
<b>Decking Options</b> .....	6-14	<b>Vinyl Railing Options</b> .....	24-26	Ceiling Stain Options.....	40
Vintage Collection .....	6	200 Series .....	24	Soffit Options .....	41
Landmark Collection.....	7	400 Series .....	25	Soffit Colors.....	42
Harvest Collection.....	8	3000 Series.....	26	Rainguard System .....	43
Legacy Collection .....	9	<b>Metal Privacy Fence</b> .....	27	<b>Fireplaces</b> .....	44-45
Reserve Collection .....	10	<b>Lighting Options</b> .....	28	Contractor Series .....	44
Terrain+ Collection.....	11	Lighting Options Gallery.....	29	Standard Series .....	44
Terrain Collection.....	12	<b>Porch Building Options</b> .....	30	New Age Series.....	45
Prime+ Collecion.....	13	Structural Column.....	31	Fireplaces Gallery.....	45
Prime Collection .....	14	Porch Post Options.....	32	<b>Kitchen Grill Cabinetry</b> .....	46
Premier Collection.....	14	<b>Stone Veneer Options</b> .....	33-34	<b>Pergola Options</b> .....	47
<b>Picture Framing Options</b> .....	15	<b>Screen Options</b> .....	35-36	<b>Stones Under Deck</b> .....	48
<b>Decking Fasteners</b> .....	15	4-Track vinyl windows .....	35	<b>Deck Furniture</b> .....	49-50
<b>Glass Rail</b> .....	15	Phantom Screens .....	35	<b>Customer Testimonials</b> .....	51
<b>Aluminum Railing Options</b> ..	16-23	ScreenEze.....	36		





# ABOUT US

Welcome to the premier deck building experience with Deck Zone. Our builders are dedicated to shaping your back yard into a heartwarming sanctuary for cherished memories, knowing we're not just building a deck but also designing an enduring legacy for your family life.

We are an Amish-owned company with a commitment to Biblical principles. We honor our core values in our projects. Choosing us means you are partnering with a team that values authenticity, integrity and excellence.

## OUR SERVICE AREA

We serve customer within a 60-mile radius of our location in Myerstown, PA

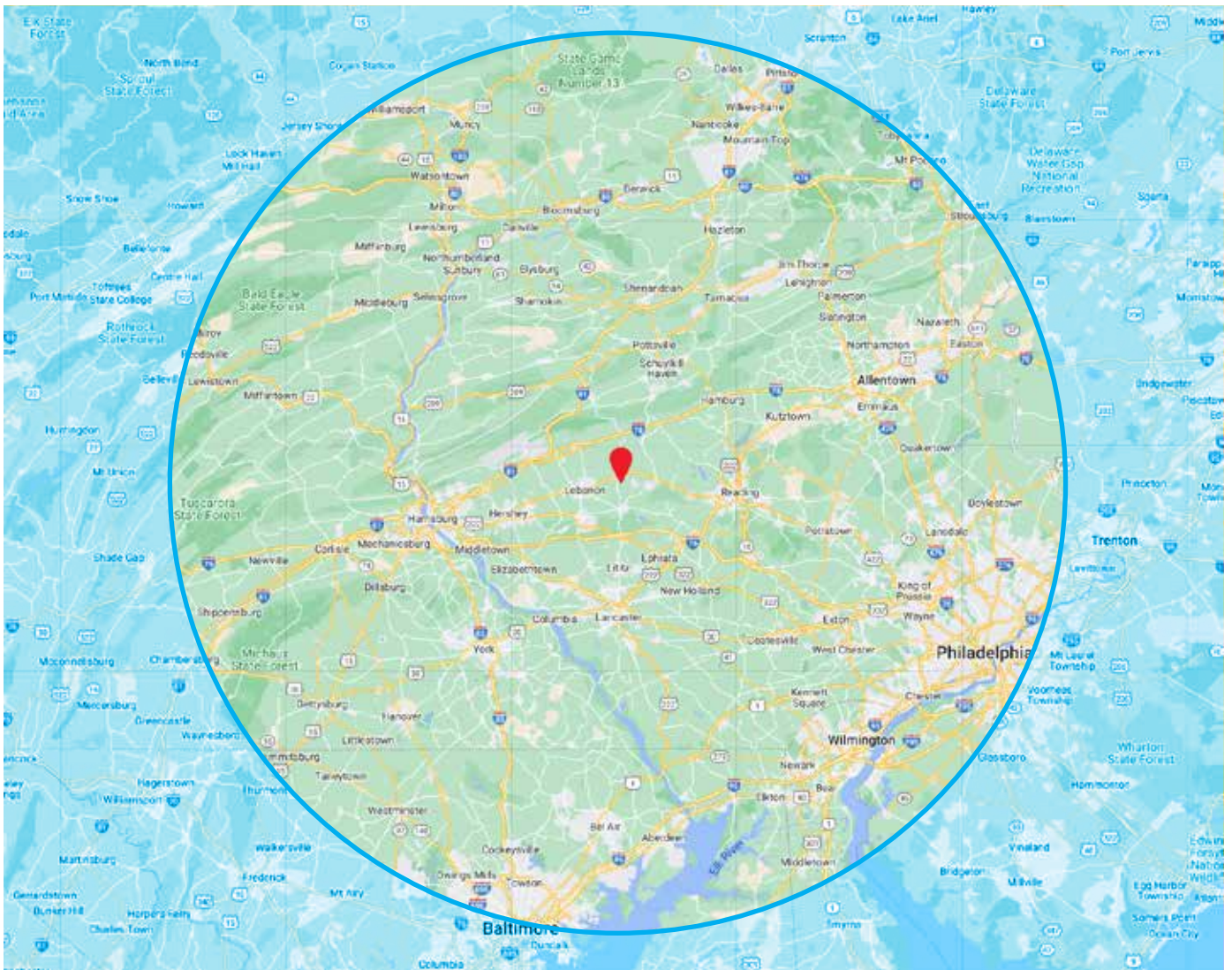

# OUR PROCESS

1. Once we receive your request, we will reach out to determine your vision.
2. We'll prepare a rough estimate for you, and if it is within your budget, we can set up an on-site meeting.
3. Create and email a proposal for signature.
4. Once signed and initial deposit of 50% collected, we will design a 3D rendering for you to see your vision.
5. Obtain permits from the local township.
6. Put your project on our schedule to become a reality.
7. Throughout the build process, we will keep you up-to-date with the daily progress.
8. Once the project is complete, we will set up a final walkthrough and inspection, along with collecting the final payment.



# PAYMENT PLAN OPTIONS

Plan Number	Description	APR	Estimated Payment Factor	Term (Total Payments)
2521	12 Months No Interest No Payments	15.99 - 24.99%	2.32%	84
2832	Reduced Rate 12.99%	12.99%	1.49%	120
9991	Risk Based Loan (9.99% - 22.99%) Based on Credit*	9.99% - 22.99%	1.32% - 2.13% Based on APR*	120
1063	HYBRID 0% for 6 Months No Payments / 13.99% for 120 Months	0% / 13.99%	1.55%	126



# DECK MODEL AVERAGE PRICES

House sq ft ideas with our models (templates and rough base price) based off ground height detached

Apr House sq ft	Width x length	Deck sq ft		Wood deck & rail	Composite deck & vinyl rail
500	10x10	100	2 people	\$4,896	\$5,460
700	12x12	144	4 people or more	\$6,192	\$6,759
960	12x16	192		\$7,578	\$8,649
1100	14x16	224		\$8,852	\$10,381
1200	12x20	240		\$8,964	\$10,539
1250	16x16	256		\$9,321	\$11,169
1400	14x20	280		\$10,491	\$12,691
1600	16x20	320		\$11,064	\$13,689

Any other size is CUSTOM with higher price tag/sq. ft. (14ft sizes are apr 5% more/sq)

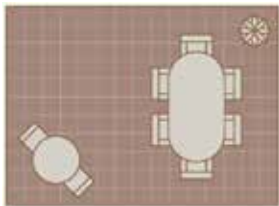

Small = 192sq'

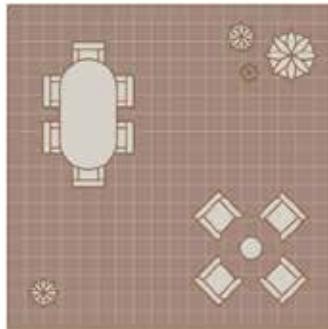

medium = 361sq'

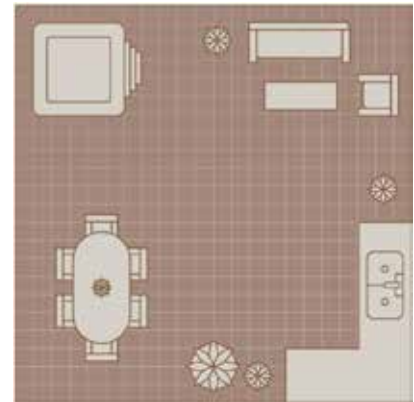

large = 529sq'

**3D DECK  
DESIGNER**

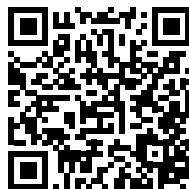

**DECK COST  
ESTIMATOR**

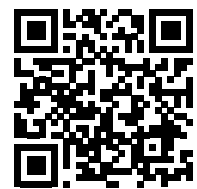

<https://www.timbertech.com/design/deck-designer/> <https://deckzone.com/deck-cost-calculator>

## OUR WARRANTY

Our 10 year labor warranty covers the workmanship, limited to:

- Only valid for original purchaser
- See manufacturers warranty for coverage on labor and materials

- Does not cover:
  - Using the product in a way it wasn't designed for
  - Damage due to weather, acts of God or lack of proper maintenance
  - Must report claims within 10 day of discovering the problem, along with photos and copy of invoice or warranty could be voided.



Our most realistic wood looks with unparalleled performance



Composite is in a class of its own, with unmatched wood looks



COLLECTION	VINTAGE®	LANDMARK®	HARVEST®	LEGACY	RESERVE	TERRAIN+™	TERRAIN	PRIME+®	PRIME / PREMIER
MATERIAL	Capped PVC (Polymer)				Capped Composite				
WARRANTY	Limited Lifetime Product Warranty; 50-Year Limited Fade & Stain Warranty				30-Year Limited Product and Fade & Stain Warranty			25-Year Limited Product and Fade & Stain Warranty	
FIRE ZONE	WUI-Compliant, Class A Flame Spread Index rated, or both*				-	Reserve FR collection WUI-Compliant	-	-	Premier Square-shouldered Boards WUI-Compliant
HEAT RESISTANCE	Stays up to 30° cooler to the touch than competitive composite decking*				Average heat resistance				
SLIP RESISTANCE	Up to 40% better slip resistance, wet or dry, than leading competitor				Average heat resistance				
PRICE	\$\$\$\$	\$\$\$	\$\$\$	\$\$\$	\$\$\$	\$\$	\$\$	\$	\$\$-\$
MOISTURE RESISTANCE	BEST	BEST	BEST	BETTER	BETTER	BETTER	BETTER	GOOD	GOOD
MULTIWIDTH DECKING	Available in 3 widths	Available in standard width only	Slate Gray & Brownstone avail. in 2 widths	Available in standard width only					
GRAYS	Coastline**	Boardwalk*	Slate Gray	Ashwood	Driftwood	Weathered Oak	Silver Maple	Sea Salt Gray	Maritime Gray™
	Dark Hickory	Castle Gate*							
BROWNS	Cypress*	American Walnut*	Kona*	Pecan	Dark Roast*	Dark Oak	Brown Oak	Dark Cocoa	Darkl Team™
	Mahogany			Mocha					
	English Walnut*			Espresso™					
TANS	Weathered Teak*	French White Oak*	Brownstone	Tigerwood	Reclaimed Chestnut™	Natural White Oak		Coconut Husk*	
				Whitewash Cedar*	Antique Leather				



VINTAGE COLLECTION®

Exotic Hardwoods

This collection captures the look of sought-after premium hardwoods with a refined wire-brushed finish and multitoneal color blending featuring highlights and lowlights.

- Complex, multitoneal colors to reflect the natural variations in exotic woods
- A low-gloss, wire-brushed finish for an authentic texture while letting the grain and colors shine through
- Best choice for fire zones thanks to Class A Flame Spread Rating & WUI-Compliance
- Multiwidth Decking options including narrow- (3.5"), standard- (5.5"), and wide-width (7.25") boards for design flexibility
- MAX (1.5" thick) boards available in Coastline, ideal for docks, boardwalks, and other commercial applications

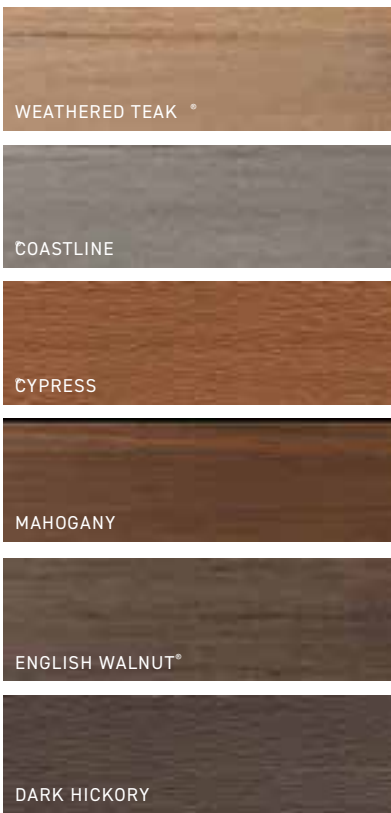



ADVANCED PVC

# LANDMARK COLLECTION®

Crosscut Hardwoods



\$36.75 / SQ. FT.

For a look that resembles popular hardwoods like white oak and walnut, choose this crosscut cathedral grain style with a matte finish and cascading color blending.

- Cascading highlights and lowlights create dramatic coloring for unique board-to-board variation
- Crosscut cathedral grain pattern with a matte finish for a soft yet textured look
- Better choice for fire zones thanks to Class A Flame Spread Rating
- Available in standard width and thickness

STANDARD



Landmark Collection® in French White Oak®, Classic Composite Series with Drink Rail



FRENCH WHITE OAK®

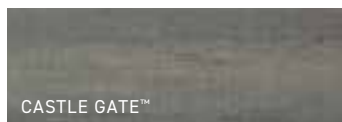

CASTLE GATE™

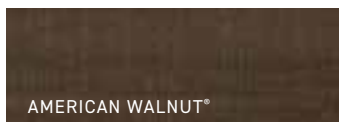

AMERICAN WALNUT®

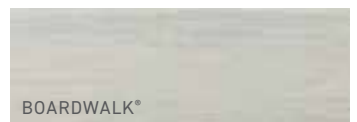

BOARDWALK®

\$34.<sup>65</sup>/SQ. FT.

ADVANCED PVC

# HARVEST COLLECTION®

## Refined Cathedral Grain

Embrace the soft, inviting versatility of attractive cathedral grain—with varying peaks, and soft, solid colors that suit a range of styles.

- Solid, soft coloring for a simple, attractive finish
- Better choice for fire zones thanks to WUI-Compliance
- All colors available in standard width. Brownstone and Slate Gray available in wide-width (7.25")
- MAX (1.5" thick) boards available in Slate Gray, ideal for docks, boardwalks, and other commercial applications

STANDARD

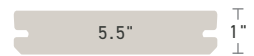

WIDE

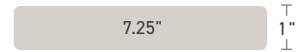

MAX



Harvest Collection® in Slate Gray



SLATE GRAY



BROWNSTONE



KONA®

Note: Kona available in square shoulder only.

**All prices shown are subject to change**



\$38.<sup>33</sup> / SQ. FT.

COMPOSITE

## LEGACY COLLECTION

### Hand-Scraped Finish

Choose this collection for an artisanal, craftsman-inspired aesthetic that features cascading hues and a textured, hand-scraped finish.

- Complex, multitone coloring that cascades through each board
- Variable grain pattern for unique board-to-board variation
- Hand-scraped finish for a textured surface
- Four-sided capping for superior moisture resistance
- Available in standard width and thickness
- Covered by 30-Year Limited Product and Fade & Stain Warranties

STANDARD

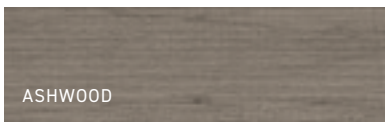
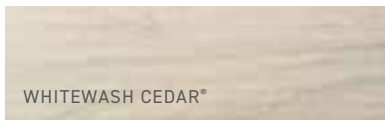
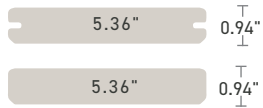

\$36<sup>.75</sup>/SQ. FT.

COMPOSITE

## RESERVE COLLECTION

### Reclaimed Wood

Capture the character-rich look and feel of reclaimed wood with bold, multitoneal colors and rustic cathedral grain.

- Advanced color blending with a mix of vibrant hues
- Heavy wire-brushed, low-gloss finish for a rustic texture
- Four-sided capping for superior moisture resistance
- Available in standard width and thickness
- Covered by 30-Year Limited Product and Fade & Stain Warranties

STANDARD

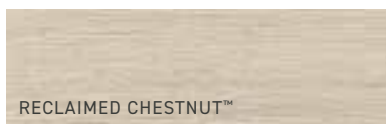
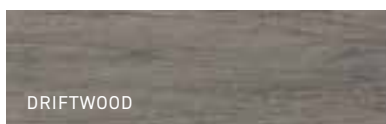
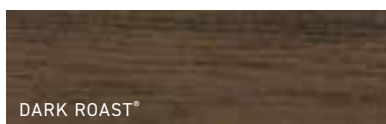
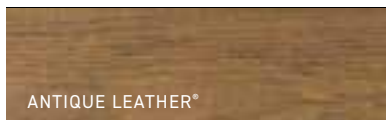
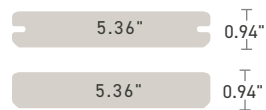

All prices shown are subject to change



\$33.<sup>60</sup>/SQ. FT.

COMPOSITE

# TERRAIN+ COLLECTION™

Subtle Wood Grain

With new and improved color blending technology, these boards deliver sophisticated colors with a subtle grain pattern like sanded white oak and walnut for a versatile, natural wood look.

- Curated palette of colors with low-gloss matte finishes that can be used in mixed-color patterns
- Compatible with CORTEX® hidden fasteners
- Four-sided capping for superior moisture resistance — even in the grooves
- Available in standard width and thickness, with a scalloped profile
- Covered by 30-Year Limited Product and Fade & Stain Warranties

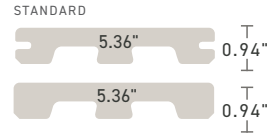

Terrain+ Collection in Dark Oak, Classic Composite Series with Premier Top Rail



\$33.<sup>60</sup>/SQ. FT.

COMPOSITE

## TERRAIN® COLLECTION

### Rugged Cathedral Grain

Capture a timeless, traditional wood look with the Terrain Collection. With subtle color variation and a textured grain, these boards deliver an attractive look for your outdoor oasis.

- Rugged cathedral grain pattern with peaks
- Embossed finish for a complex texture that hides everyday wear and tear
- Four-sided capping for superior moisture resistance — even in the grooves
- Available in standard width and thickness, with a scalloped profile
- Covered by 30-Year Limited Product and Fade & Stain Warranties

STANDARD

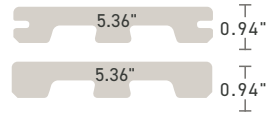

Terrain Collection in Silver Maple

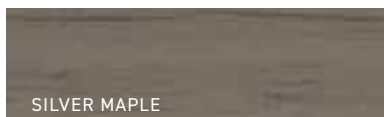

All prices shown are subject to change



\$30.45 / SQ. FT.

COMPOSITE

## PRIME+ COLLECTION®

Timeless Wood Grain

Choose this collection for a traditional wood aesthetic with natural, inviting colors and a textured straight grain pattern.

- Moderately color blended
- Scalloped profile
- Three-sided capping for excellent moisture resistance
- Available in standard width and thickness
- Covered by 25-Year Limited Product and Fade & Stain Warranties

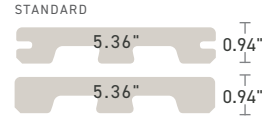

Prime+ Collection in Dark Cocoa, RadianceRail Express®

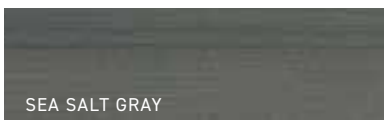

SEA SALT GRAY



COCONUT HUSK®

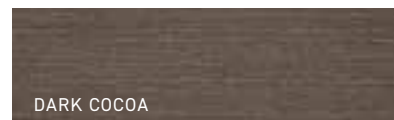

DARK COCOA

\$30.45 / SQ. FT.

COMPOSITE

# PRIME COLLECTION

Painted Wood

For an opaque stained or painted wood look, opt for the Prime Collection, which features earthy, vivid wood stain colors. Featuring the same colors as the Premier Collection, but with a scalloped board for a lighter weight, without compromising a secure underfoot feel.

- A subtle straight grain pattern
- Three-sided capping for excellent moisture resistance
- Available in standard width and thickness, with a scalloped profile
- Covered by 25-Year Limited Product and Fade & Stain Warranties

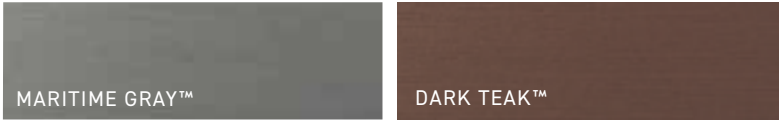
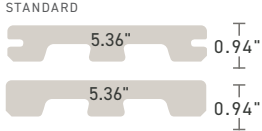

\$30.45 / SQ. FT.

COMPOSITE

# PREMIER COLLECTION\*

Painted Wood

The Premier Collection features the same opaque stained or painted wood look of the Prime Collection, but with a full-profile board.

- A subtle straight grain pattern
- Premier square profile boards feature WUI-Compliance for a better choice for fire zones
- Three-sided capping for excellent moisture resistance
- Available in standard width and thickness, with a full-profile board
- Covered by 25-Year Limited Product and Fade & Stain Warranties

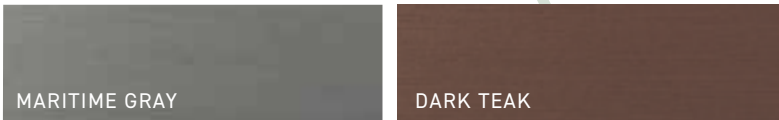
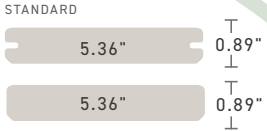

All prices shown are subject to change



## PICTURE FRAMING OPTIONS

\$9-13/FT.LN.



## WEDGECLIP™



hidden decking fasteners

CAMO hidden deck clips are the best way to install grooved decking.

## GLASS RAIL

*C70 Veranda*

CALL FOR  
PRICING



# ALUMINUM RAILING OPTIONS

## AMERICAN SERIES

\$68.<sup>25</sup> / FT. LN.

### PRODUCT DETAILS

- Level and stair rail lengths come in 5', 6', 7' or 8' sections
- Available in 36" or 42" heights
- Meets IRC and IBC (42" only) code requirements
- Boxed sections include top and bottom rails, mounting brackets and hardware, infill\* and the installation guide

\*Except Horizontal Cable

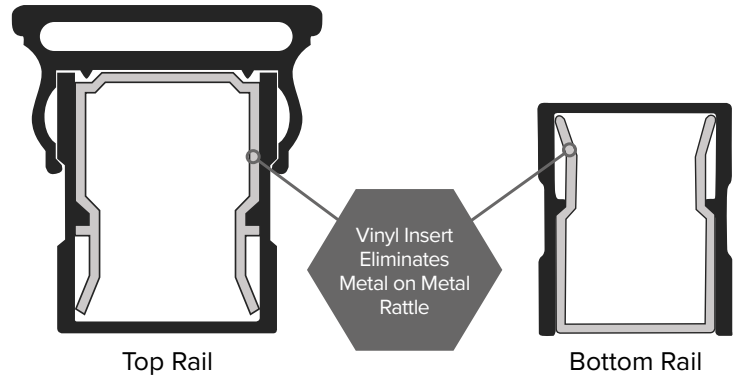

### STANDARD COLORS

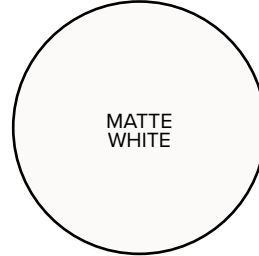
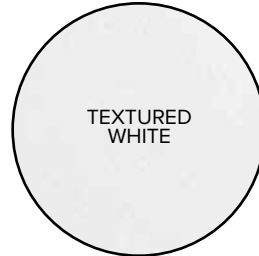

### INFILL OPTIONS

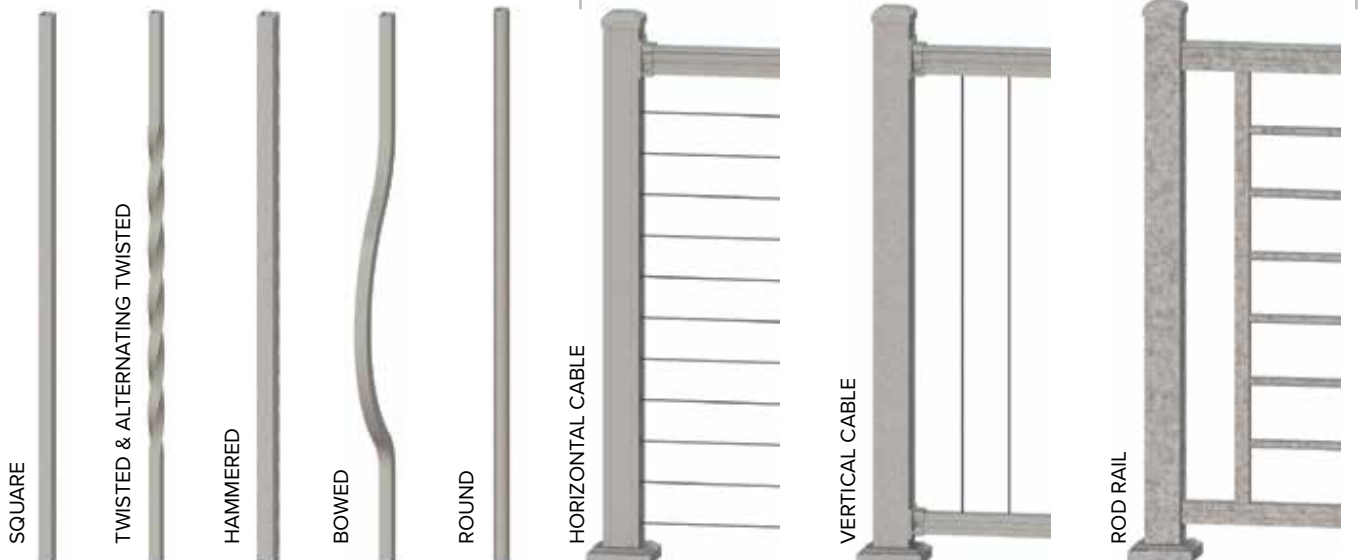

All prices shown are subject to change



## ROD RAIL INFILL



\$89.<sup>25</sup> / FT. LN.

## CABLE RAIL INFILL

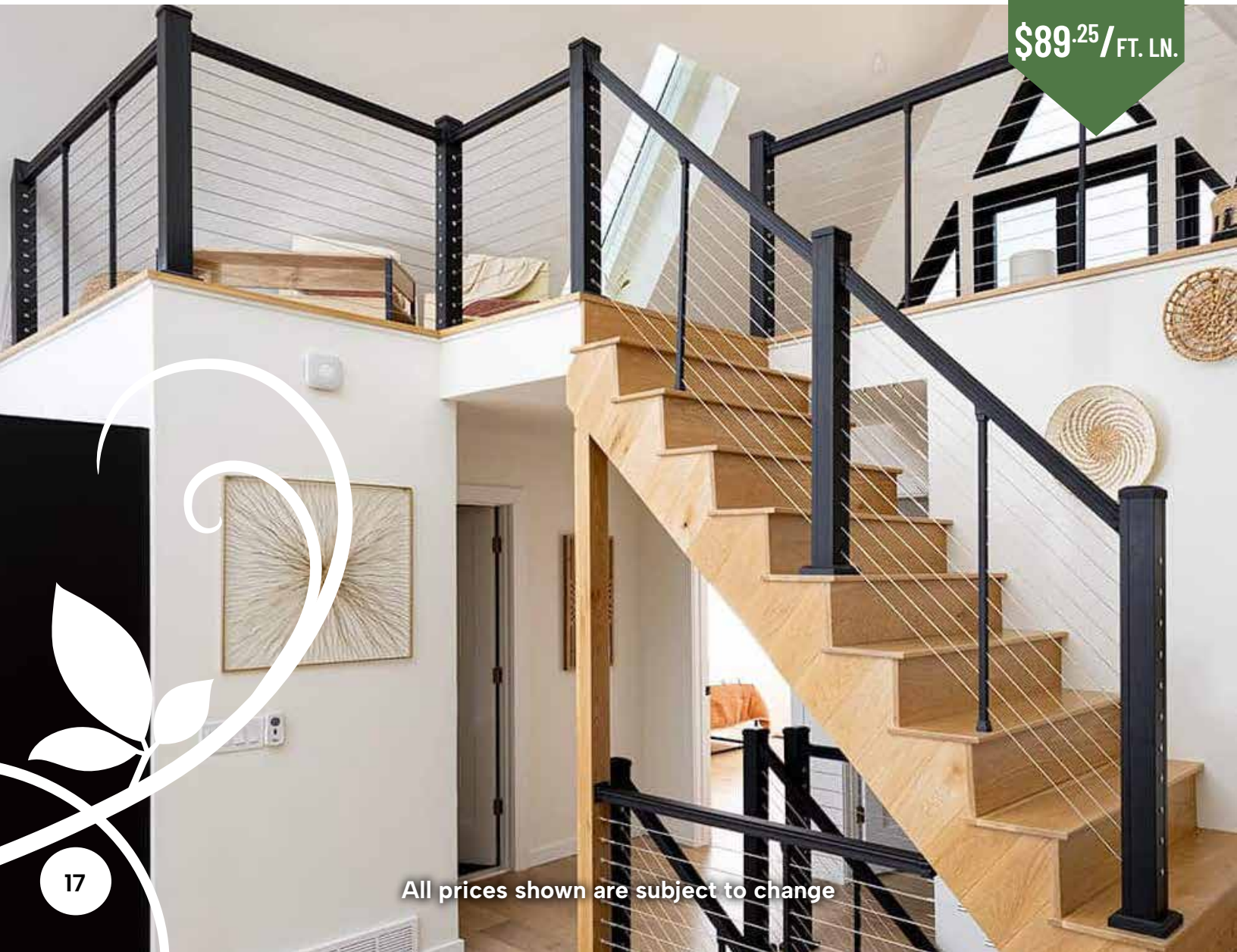

\$89.<sup>25</sup> / FT. LN.





Textured Black with Vertical Cable



Textured Black with Square Balusters



Matte White with Black Square Balusters



Textured Black with Horizontal Cable





# ALUMINUM RAILING OPTIONS

## CHESAPEAKE SERIES

\$85.<sup>05</sup> / FT. LN.

### PRODUCT DETAILS

- Level and stair rail lengths come in 6' or 8' sections
- Available in 36" or 42" heights
- Meets IRC and IBC (42" only) code requirements
- Boxed sections include top and bottom rails, mounting brackets and hardware, infill\* and the installation guide

\*Except Horizontal Cable

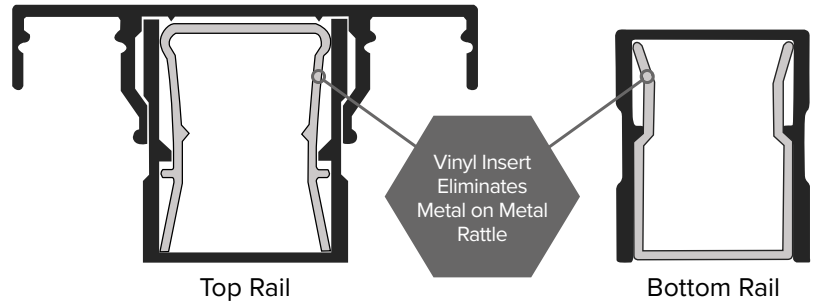

### STANDARD COLORS

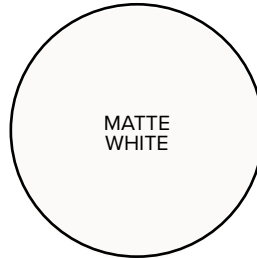
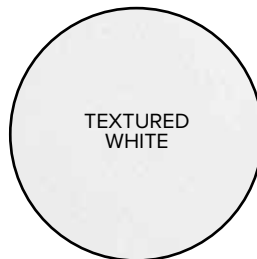

### DRINK RAIL

Select any full-profile, square-shouldered deck board. Not compatible with grooved or scalloped boards or glass infill.

available in 5.5" and 7.25" rail cap





Textured White with Horizontal Cable



Textured Black with Square Balusters



Textured Bronze with Square Balusters



Matte Black with Vertical Cable



**ENGINEERED FOR  
UNDER-RAIL LIGHTING**





# ALUMINUM RAILING OPTIONS

## OUTLOOK SERIES

\$67.<sup>20</sup> / FT. LN.

### PRODUCT DETAILS

- Level rail lengths come in 5', 6', 7' or 8' and stair rail lengths come in 4', 5' or 6'
- Available in 36" or 42" heights
- Meets IRC and IBC (42" only) code requirements
- Boxed sections include top and bottom rails, mounting brackets and hardware, infill and the installation guide

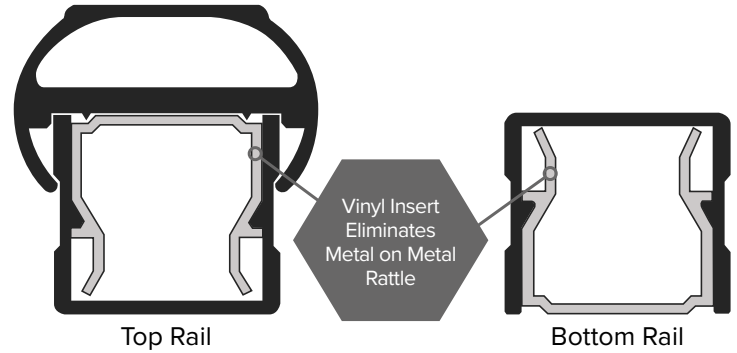

\*Except Horizontal Cable

### STANDARD COLORS

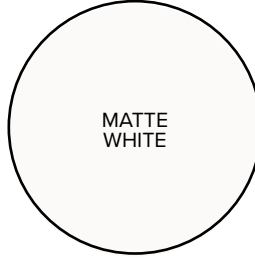
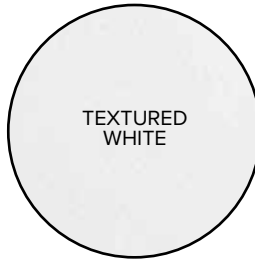

### INFILL OPTION



All prices shown are subject to change





Matte Black with Square Balusters



Matte White with Square Balusters

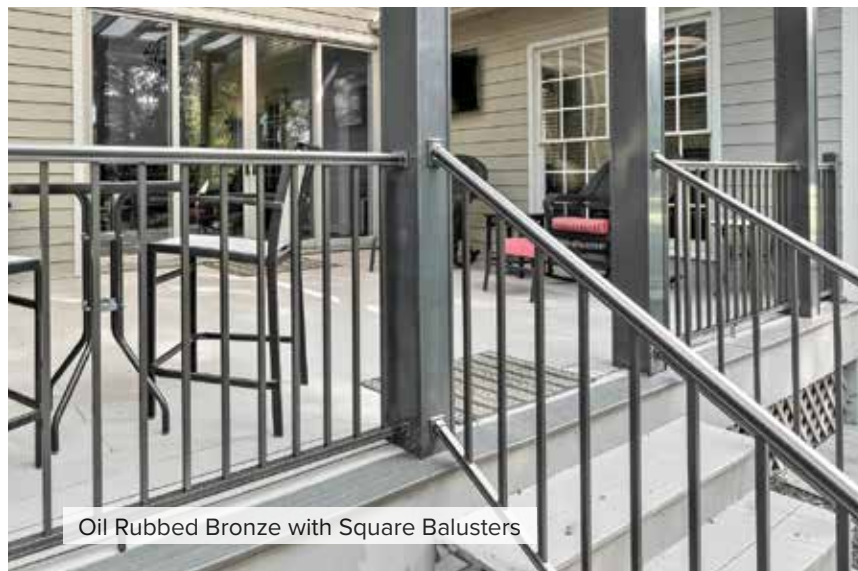

Oil Rubbed Bronze with Square Balusters

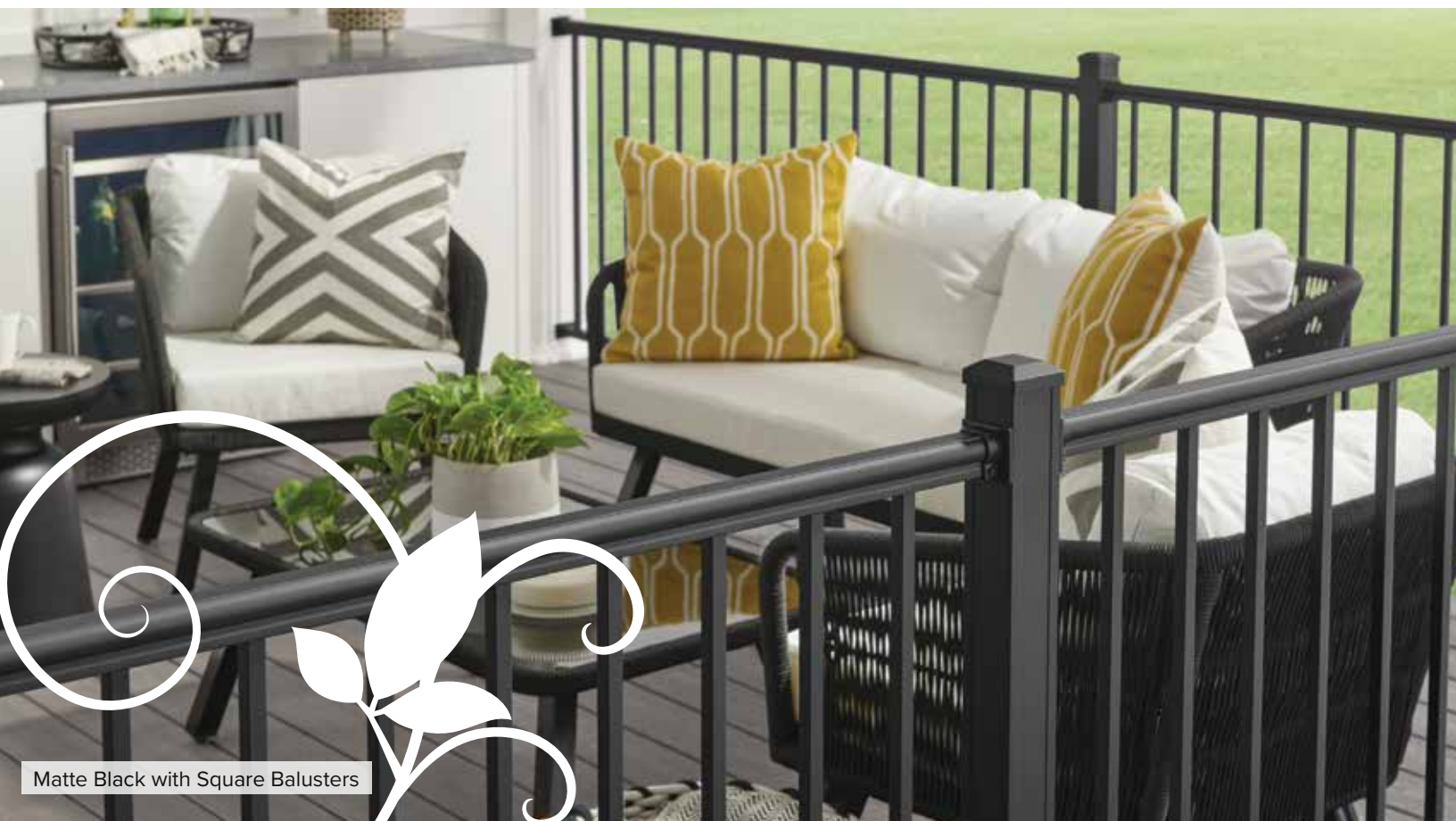

Matte Black with Square Balusters



# VINYL RAILING OPTIONS

## 200 SERIES

\$30.<sup>45</sup>/FT. LN.

### PRODUCT DETAILS

- 3 1/8" Wide Top Rail
- Railing Height Options: 36" · 42"
- Railing Length Options: 5' · 6' · 7' · 8' · 10'

### INFILL OPTIONS

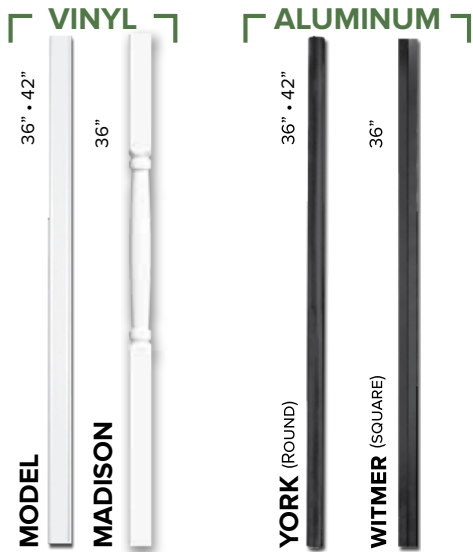

### PROFILE

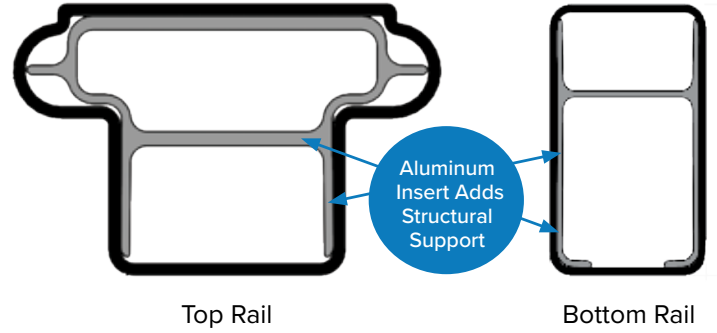

### COLOR OPTIONS

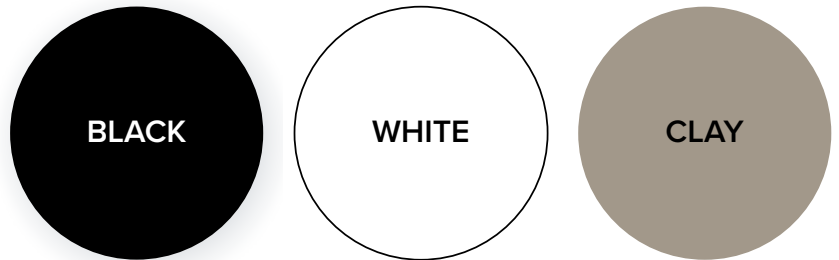

All prices shown are subject to change



# VINYL RAILING OPTIONS

## 400 SERIES

\$42.00 / FT. LN.

### PRODUCT DETAILS

- Pre-Attached Aluminum Deckboard Receiver on Top Rail (deckboard not included)
- Railing Height Options: 36" · 42"
- Railing Length Options: 6' · 8' · 10'

*Pictured Above:*

- a. White Railing with York Infill*
- b. White Railing with White Model Infill*
- c. White Railing with White Model Infill*

### PROFILE

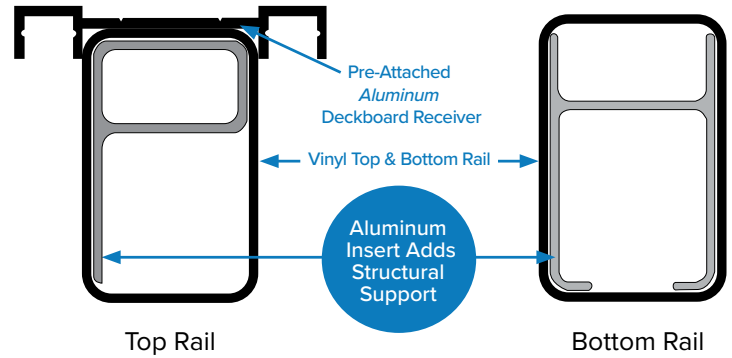

a

# VINYL RAILING OPTIONS

## 3000 SERIES

\$49.<sup>35</sup> / FT. LN.

### PRODUCT DETAILS

- 3" Wide Top Rail
- Railing Height Options: 36" · 42"
- Railing Length Options: 4' · 6' · 8' · 10'

\*Use only for applications 30" or less from ground level

*Pictured Above:*

- a. White Railing with White Model Infill*
- b. Almond Railing with York Infill*
- c. White Railing with York Infill*

### PROFILE

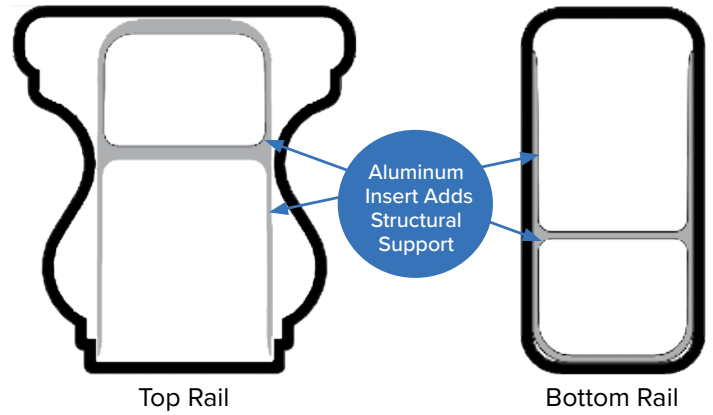

All prices shown are subject to change



# METAL PRIVACY AND DECORATIVE FENCE

CALL FOR PRICING

Freesia Decorative Screen Panels



Aztek Decorative Screen Panels



Slate Decorative Screen Panels

## POST & ACCENT LIGHTS

Sizes available for 2½", 3¼" and 4" Posts

### POST CAP LIGHTS

3000k LED

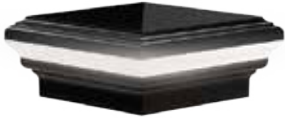

PYRAMID



DECORATIVE

### POST CAP DOWNLIGHTS

3000k LED



PYRAMID



DECORATIVE

### POST & STAIR ACCENT LIGHT

3000k LED



### POST CAPS (NO LIGHTS)



PYRAMID



DECORATIVE

### UNDER RAIL LIGHTING



Only available for Chesapeake Series

## LIGHTING ACCESSORIES

### LIGHTING CONTROL HUB & POWER SUPPLY



- Timer lets you choose 1-9 hours of light, or dusk-to-dawn
- Dimmer mode with 9 brightness levels
- Adjustable photocell sensor to control for ambient light
- **Walk Away** feature for safe exiting before lights go out
- Aluminum housing to match railing
- Power Supply available in 60w or 120w
- Expandable Power Splitter available for both 60w or 120w power supply

### POST LIGHT WIRE KIT

- KIT INCLUDES:
- Staples
  - 2-way splitter
  - 5' and 9' wire extensions

### WIRE EXTENSIONS, WIRE SPLITTERS

- WIRE EXTENSIONS:
- 2', 5', 9' Lengths Available
- WIRE SPLITTER KITS:
- 2-Way Kit: Includes (1) 8" input cable to (2) 8" output cables
  - 3-Way Kit: Includes (1) 8" input cable to (3) 10" output cables

### 2" POST ADAPTER

- Made to fit fence posts
- Fits 2" Posts
- Uses 2½" Cap for 2" Post





# LIGHTING OPTIONS GALLERY

CALL FOR  
PRICING



Deck Lights



# PORCH BUILDING OPTIONS





# STRUCTURAL COLUMNS

CALL FOR PRICING

## DEPENDABLE STRENGTH

Superior's beautiful vinyl columns give your home a refined look while requiring little effort to maintain. Each structural post and column contains an aluminum insert that provides support for a roof.

**Load Rating:** With full length extruded aluminum inserts.



### NEWEL POSTS



### POST CAPS



### POST TRIM

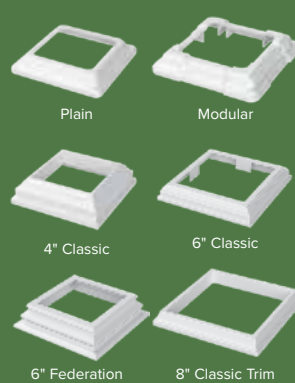

### POST WRAP



# PORCH POST COLOR OPTIONS

CALL FOR PRICING

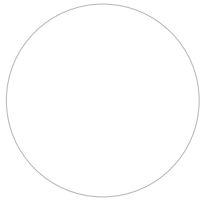

White

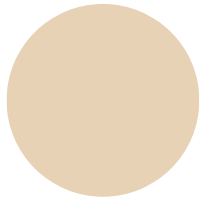

Almond

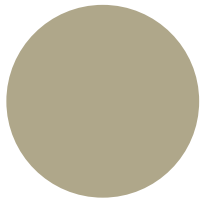

Clay



Natural  
(Unstained)



Cedar



Mahogany



Walnut



Clear



Cinder



Standard  
Post



6"  
Post Base



36" Decor  
Post Base



Tapered  
Post



Standard  
Post



16"  
Post Base



36" Decor  
Post Base



# STONE VENEER OPTIONS (DRY STACK)

CALL FOR PRICING



Capital Sky



District View



Georgetown Run



National True



Monument Gate





# STONE VENEER OPTIONS WITH MORTAR *call for price*

CALL FOR PRICING



Huntington Gray®



Chesterbrooke Blend®



Clover Creek™



Brookfield Bluff®



Yarnton™



Berwick™



Sherwood™



Andover™



Tolesbury™



Seneca Limestone®  
Gray Sq./Rect.



All prices shown are subject to change



# SCREENS w/ 4track vinyl window system

\$144.<sup>90</sup>/FT. LN.

for light duty 4-season rooms



# PHANTOM SCREENS

Lots of material styles to choose from!



CALL FOR PRICING





# SCREENEZE®

The No-Spline Screen Porch System®

\$110.25/FT. LN.

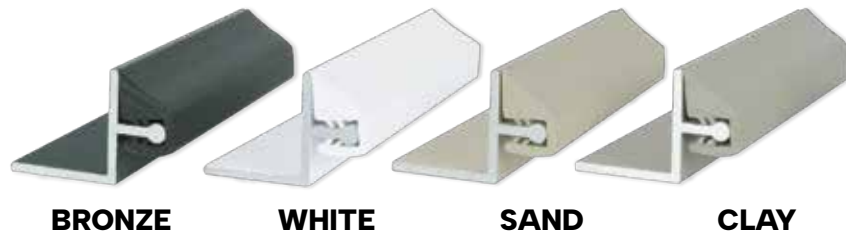

BRONZE

WHITE

SAND

CLAY

## FEATURES & BENEFITS

- No Spline | No Staples
- Span Openings Up To 150 Sq Ft
- Self Tightening | Self Stretching
- Easy To Replace Damaged Screen
- Reduce Call Backs
- 10 Year Limited Warranty
- Screws Included
- Install On The Inside, Outside Or Center Of Your Porch Post/Rail Design

## INSTALLATION

- Installation instructions included in shipping tube
- Visit our website for more info: [SCREENEZE.com/](http://SCREENEZE.com/)

## SPECS

- PVC Vinyl Cap made of window grade virgin vinyl with UV inhibitor
- Aluminum Base made of solid aluminum alloy
- Baked on polyester paint
- Color coordinated screws included
- Aluminum Base: 3/4" x 3/4", 8' or 12' in length
- Vinyl Cap: 3/8" x 1/2", 8' or 12' in length
- Made in the USA

All prices shown are subject to change



# ROOF OVERS GALLERY



Emmaus, PA



Hummelstown, PA



Hummelstown, PA



Emmaus, PA



Hummelstown, PA



Hummelstown, PA



Harrisburg, PA



Hummelstown, PA



Lititz, PA



Annaville, PA



Hummelstown, PA



Hummelstown, PA



Hummelstown, PA

## ABM PANELS

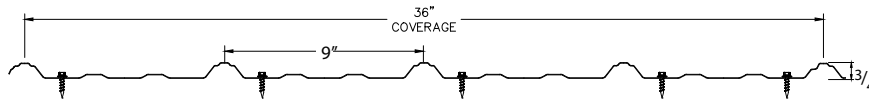
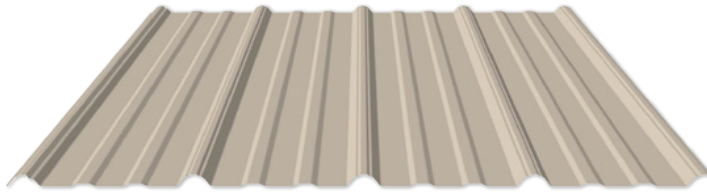

\$3.87/SQ. FT.

## AB SEAM PANELS

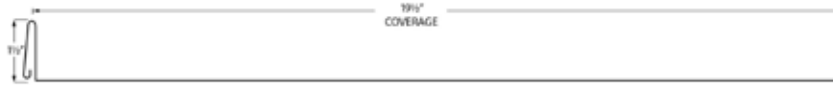

\$8.40/SQ. FT.

### Why Fluoropon®?

For over 50 years, panels using Valspar's Fluoropon® coatings (made with 70% Kynar®500/Hylar®5000 resins) have helped protect commercial, industrial, and residential buildings around the world. This high-performance fluoropolymer (PVDF) resin, with its extraordinary capability to retain color and gloss, keeps coated metal looking vibrant and appealing for decades.

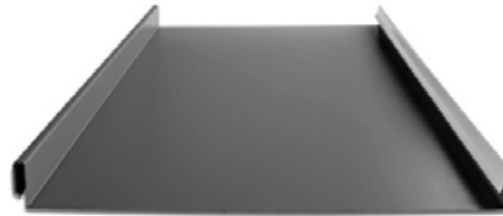

## ROOFING COLORS

### Metal Roofing (optional on all pavilions)



Black



Charcoal



Gray



Brown



Clay



Tan



White



Stone



Burnished Slate



Red



Blue



Evergreen



Copper

## ROOF SHINGLE COLOR CHART

CALL FOR PRICING



Atlantic Blue

Emerald Green

Dual Brown

Rustic Black

Virginia Slate

Oxford Gray

Rustic Slate

Rustic Redwood

Weatherwood

Old English Pewter

Rustic Cedar

All prices shown are subject to change



**CEILING BEAMS** 7.25"x 7.25"

**\$22.<sup>05</sup> / FT. LN.**



**SHIP LAP WALL & CEILING BOARD**

**\$10.<sup>50</sup> / SQ. FT.**



# WOOD OPTIONS

\$5.<sup>51</sup>/SQ. FT.

\$4.<sup>46</sup>/SQ. FT.

Beaded 1x6  
tongue & groove



nickel gap 1x6  
tongue & groove



# CEILING STAIN OPTIONS

\$3.<sup>62</sup>/SQ. FT.

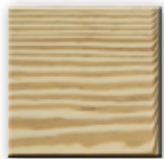

PT Wood  
(unstained)



PT Wood  
(Clear Stain)



PT Wood  
(Cedar Stain)



PT Wood  
(Mahogany Stain)



PT Wood  
(Gray Stain)



PT Wood  
(Walnut Stain)



PT Wood  
(Cinder Stain)



Cedar Wood  
(unstained)



Cedar Wood  
(Clear Stain)



Cedar Wood  
(Cedar Stain)



Cedar Wood  
(Mahogany Stain)



Cedar Wood  
(Gray Stain)



Cedar Wood  
(Walnut Stain)



Cedar Wood  
(Cinder Stain)



RC Wood  
(unstained)



RC Wood  
(Clear Stain)



RC Wood  
(Cedar Stain)



RC Wood  
(Mahogany Stain)



RC Wood  
(Gray Stain)



RC Wood  
(Walnut Stain)



RC Wood  
(Cinder Stain)



White Vinyl



Almond Vinyl



Sand Castle Decking



Harbor Gray Decking



Rosewood Decking



Teakwood Decking



Cedar Shake Shingles

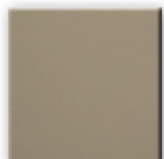

Clay Vinyl



Black Vinyl



Weather IPE Decking



Driftwood Decking



Amberwood Decking



Black Walnut Decking



Midnight Gray Rubber  
Slate Shingle

All prices shown are subject to change



# SOFFIT

CALL FOR PRICING

## BEADED SOFFIT/WAINSCOT

- Hidden Vent Soffit
- AirCanal Channel Venting
- Dual Channel Stability
- Beaded Reinforcement
- Lifetime Limited Warranty
- Color Availability: *White, Linen, Sand, Hero Blue and Clay*

Not for use as vertical siding

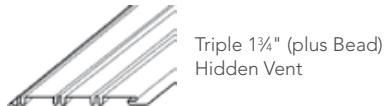

## WOODHAVEN® SOFFIT

CALL FOR PRICING

- Hidden Vent or Solid Soffit
- AirCanal Channel Venting
- Dual Channel Stability
- Lifetime Limited Warranty
- Solid and Hidden Vent Color Availability:

*White, Linen, Antique White, Birchwood, Cream, Alabaster, Sand, Chateau, Sandalwood, Gray, Pewter, Clay, Everest, Prairie, Sage, Stone, Canyon, Granite, Aspen, Pueblo, Nautica, Mountain Berry, Timberline, Sea Slate, Nightfall, Neptune, Musket Brown*

Not for use as vertical siding



# SOFFIT COLORS

## LIFESTYLE COLLECTION



## SIGNATURE COLLECTION

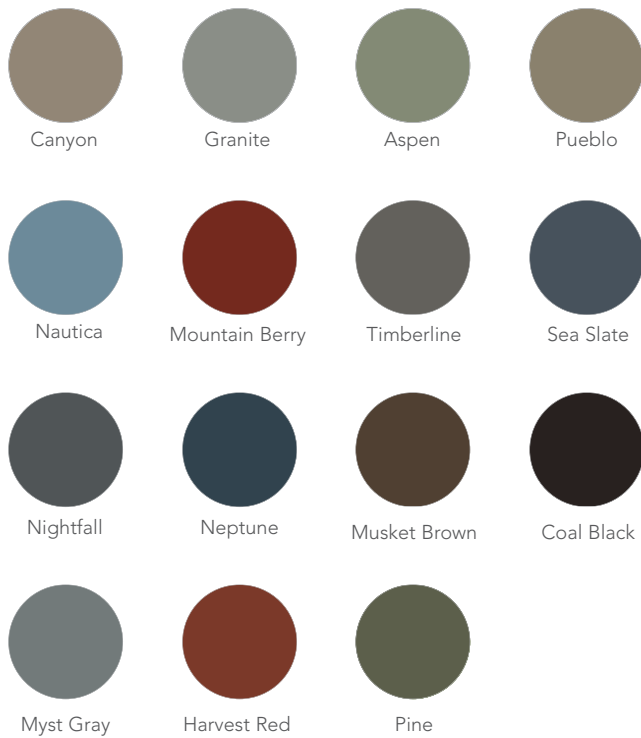

Always refer to our color selector for accurate color representation.

Beaded	Woodhaven			
	Triple 1 3/4" Hidden Vent	Triple 1 3/4" Solid	Triple 3 1/3" Hidden Vent	Triple 3 1/3" Solid
				White
				Linen
				Antique White
				Cream
				Alabaster
				Chateau
				Sandalwood
				Hero Blue
				Gray
				Pewter
				Clay
				Everest
				Prairie
				Sage
				Canyon
				Granite
				Aspen
				Pueblo
				Nautica
				Mountain Berry
				Timberline
				Sea Slate
				Nightfall
				Neptune
				Musket Brown
				Coal Black
				Myst Gray
				Harvest Red
				Pine



# RAINGUARD SYSTEM

*under decking to provide dry space under deck*

**\$12.<sup>60</sup> / SQ. FT.**





# FIREPLACES

## CONTRACTOR SERIES

Available in 24", 36", 48" per arched lintel, straight lintel, or see thru model



Arched Lintel



Straight Lintel



See-Through Arched Lintel



See-Through Straight Lintel

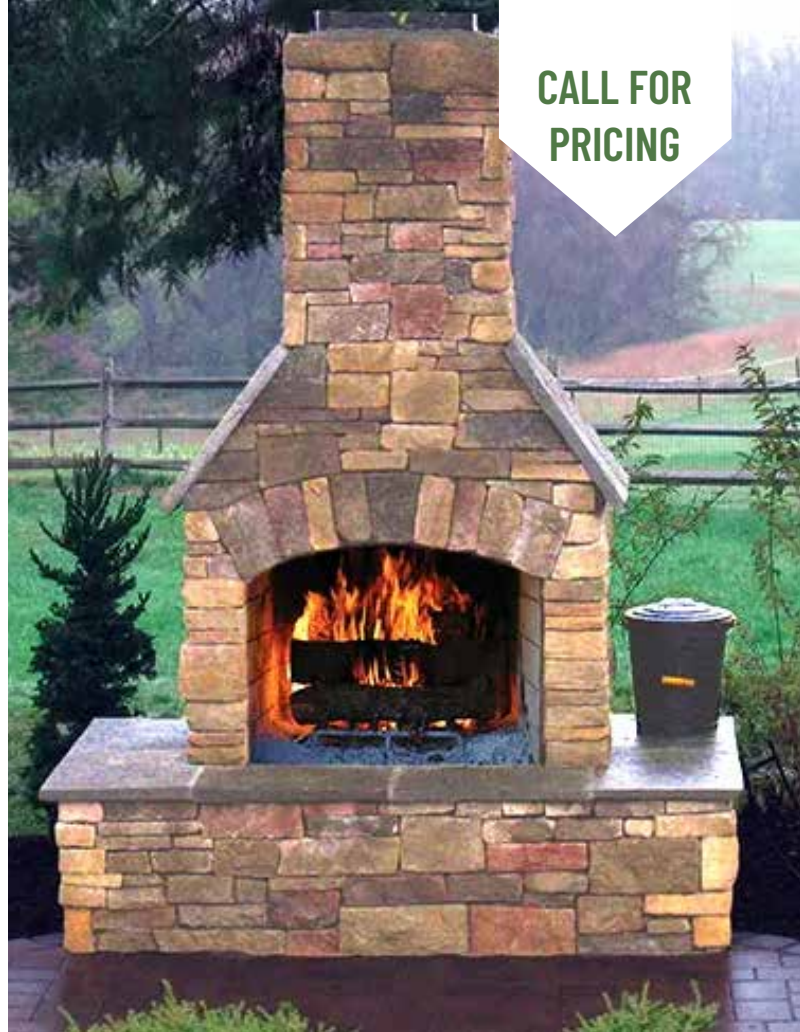

## STANDARD SERIES

Available in 24", 36", 48" per arched lintel, straight lintel or see-thru model.



Arched Lintel



Straight Lintel



See-Through Arched Lintel



See-Through Straight Lintel

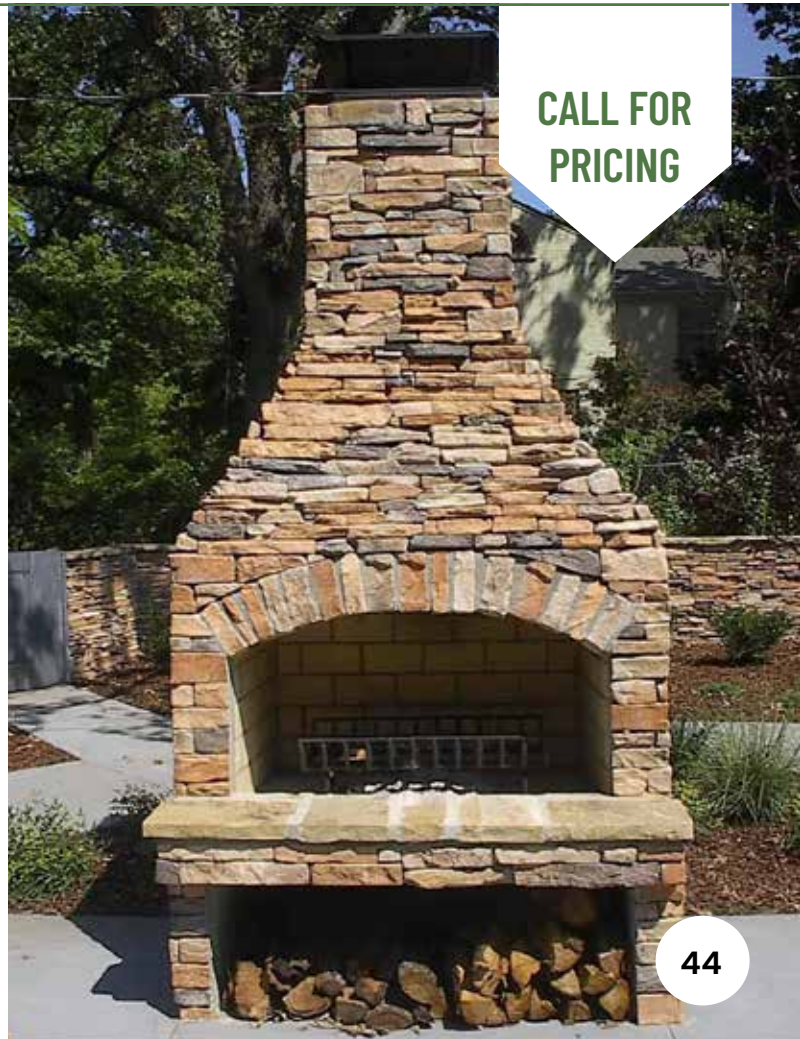



# NEW AGE SERIES



Available in 36", 42", 48", 60", 72" model

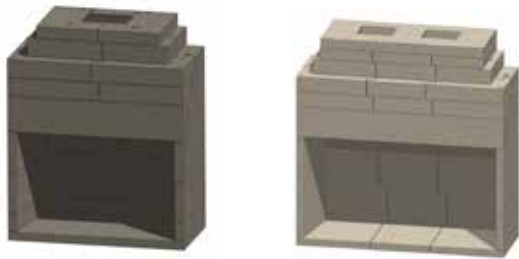

CALL FOR PRICING

## FIREPLACES GALLERY





# KITCHEN GRILL CABINETRY

CALL FOR PRICING



## CHALLENGER COASTAL COLLECTION

For pre-configured grill islands, Challenger's Coastal Collection provides a "no-assembly" solution for aluminum outdoor kitchens. Empire stocks three packages which includes your choice of three different Blaze grills. With multiple color combinations that ship directly to our warehouse, this quick option still allows for choice.

## COASTAL COLLECTION

Choose from one of our pre-designed Coastal Collection kitchen islands that fits your space and start entertaining right away. These islands are the perfect choice if you are looking for a hassle free option, that requires no assembly.

CALL FOR PRICING

### 5' GRILL ISLAND PACKAGE

- Ships fully assembled, ready for grill installation
- Single Drawer Door
- Gas Grill Base
- Pull Out Waste Bin with Drawer
- Shaker Door Style
- Includes your choice of 3 Blaze Grills for NG or LP
- Add Color-Matched To Kick Package for finished look.



### 8' GRILL ISLAND PACKAGE

- 21.5" refrigerator opening, sink base
- Gas Grill Base
- Pull Out Waste Bin with Drawer
- Shaker Door Style
- Single Drawer Door Base
- Includes your choice of 3 Blaze Grills for NG or LP
- Add Color-Matched To Kick Package for finished look.



## CABINET COLOR OPTIONS



*\*Custom color available upon request*

## COUNTERTOP COLOR OPTIONS

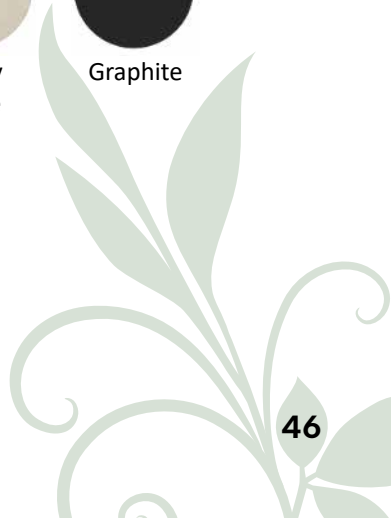



## MODERN METAL PERGOLAS



\$9,446<sup>.85</sup>  
TO  
\$12,071<sup>.48</sup>

**4 POSTS + 4 BEAMS + 17 LOUVERS +**  
Premium Powder Coat Finish  
Motorized Adjustable Louvers  
Powered by Somfy (Hand-held Remote)  
Easy Power Plug  
Post Height Adjustment  
Stainless Steel Hardware  
Modular Configuration Ready  
Enhancement Ready

## TRIANGLE PERGOLAS



\$2,089<sup>.50</sup>

### STANDARD FEATURES

8' x 8' x 11'  
Double 2' x 6' Header w/ Double Corner Braces  
Top Header Plates  
2' x 6' Runners with Decorative Ends  
2' x 4' Top Runners (except Vinyl – 2'x2')  
5' x 5' Posts  
36" Post Base  
Mounting Brackets

## WALL MOUNT PERGOLAS



CALL FOR  
PRICING

Wall mounted pergola kits are built as a true extension of your home, so you can enjoy convenient outdoor living. Our wall mounted pergola kits create an open-air space in your yard, so your family can relish in nature's divine peace all year round. Once you've assembled your wall mounted pergola kit, set up your pergola space with lounge chairs for deep relaxation or a table and chairs for festive gatherings.

**STONES UNDER DECK** *for low decks where stone will be less visible*

**\$2.10** / SQ. FT.

## **GRAY 2B CLEAN APR**



**STONES UNDER DECK** *for higher decks or visible stones*

**\$3.15** / SQ. FT.

## **RIVERSTONE**



**STONES UNDER DECK** *for higher decks or visible stones*

**\$3.15** / SQ. FT.

## **PEA GRAVEL**





# DECK FURNITURE

CALL FOR PRICING



Poly Fanback Settee



Poly Balcony Settee



Wood Mail Box Post



Poly Fanback Dining Chair



Poly Balcony Swivel Bar Chair



Poly Fanback Lounge Chair



Wood 4' English Garden Bench



Wood 4' West Chester Horizontal Porch Swing



Wood Fan-Back Settee



Poly Swivel Bar Stool



Mission Deep Seating Love Seat



Mission Deep Seating Chair



Poly English Garden Bar Arm Chair



Poly West Chester Swing



Poly Easy Swing



Poly Fanback Chair



Poly Curve-Back Glider



Greenhouse Planters



Greenhouse Raised Garden Bed with Cover



Deck Storage Box



Greenhouse Raised Garden Bed



Greenhouse Window Box



Outdoor Patio Island



Poly Planter



Poly 3' x 6' Six Foot Picnic Table



Poly 43" Square Bar Height Table



Poly 60" Round Dining Height Table



Poly Round Side Table



Poly Octagonal Picnic Table



Mission Coffee Table



Poly Conversation Table





# SOME OF OUR CUSTOMERS TESTIMONIALS

Levi and his team were the most efficient, thorough and excellent contractors I've ever worked with - the cost of their services being well worth the expense! Highly recommend Levi and his coworkers for any carpentry and building maintenance activities.

- Steve K.

5 ★★★★★



We had the pleasure of having Levi and his team work on a couple projects for us. They were very professional with great skills doing an excellent job along with the best customer service!

- Agapi P.

5 ★★★★★



Used Deck Zone for a deck repair of rotted trim around a support end joist. They quoted us roughly half the cost of bigger companies and other folks. The joist itself had minimal rot and they debrided that and filled it. Very professional and terrific to work with.

- Dean C.

5 ★★★★★



Highly recommend! Easy to work with, respectful. Built us a beautiful new deck!

- Jennifer S.

5 ★★★★★

By far the best customer service I could of ever hoped for. Very professional and extremely skilled employees as well as company owners.

- Daniel B.

5 ★★★★★



# DECK ZONE